



晶采光電科技股份有限公司
AMPIRE CO., LTD.

Specifications for LCD module

Customer	
Customer part no.	
Ampire part no.	AM-640480VTZQW-00H
Approved by	
Date	

- Preliminary Specification
- Approved Specification

AMPIRE CO., LTD.

4F., No.116, Sec. 1, Xintai 5th Rd., Xizhi Dist., New Taipei City 221, Taiwan (R.O.C.)

新北市汐止區新台五路一段 116 號 4 樓(東方科學園區 A 棟)

TEL:886-2-26967269 , FAX:886-2-26967196 or 26967270

Approved by	Checked by	Organized by
<i>Patrick</i>	<i>Kokai</i>	<i>Mark</i>

This Specification is subject to change without notice.

RECORD OF REVISION

Revision Date	Page	Contents	Editor
2019/11/22	---	New Release	Mark
2020/10/14		Add VLED input voltage information	Mark
2020/10/16		Modify the LED Backlight information	Mark
2021/09/14		Add Voltage and current information for LED driver	
2022/04/19	4	Surface treatment	Jessica

1. Features

5.7 inch Amorphous-TFT-LCD (Thin Film Transistor Liquid Crystal Display) module. This TFT LCD has a 5.7 (4:3) inch diagonally measured active display area with 640x480 (640 horizontal by 480 vertical pixels) resolution. This module is composed of a 5.7" TFT-LCD panel and backlight unit.

- (1) Construction: a-Si TFT-LCD with driving system, White LED Backlight.
- (2) LCD type : IPS
- (3) Number of the Colors : 262K colors (R,G,B 6bit digital each)
- (4) Interface: 18 Bit TTL RGB interfaces. 40 pin.
- (5) LCD Power Supply Voltage: 3.3V single power input, built-in power supply circuit.

2. Physical Specifications

Item	Specifications	unit
Display size (diagonal)	5.7	inch
Resolution	640 (W) x RGB x 480 (H)	dot
Pixel pitch	0.18 (W) x 0.18 (H)	mm
Color configuration	R.G.B Vertical stripe	
Display Mode	Normally Black	
Surface treatment	Anti Glare and Hard Coating (3H)	

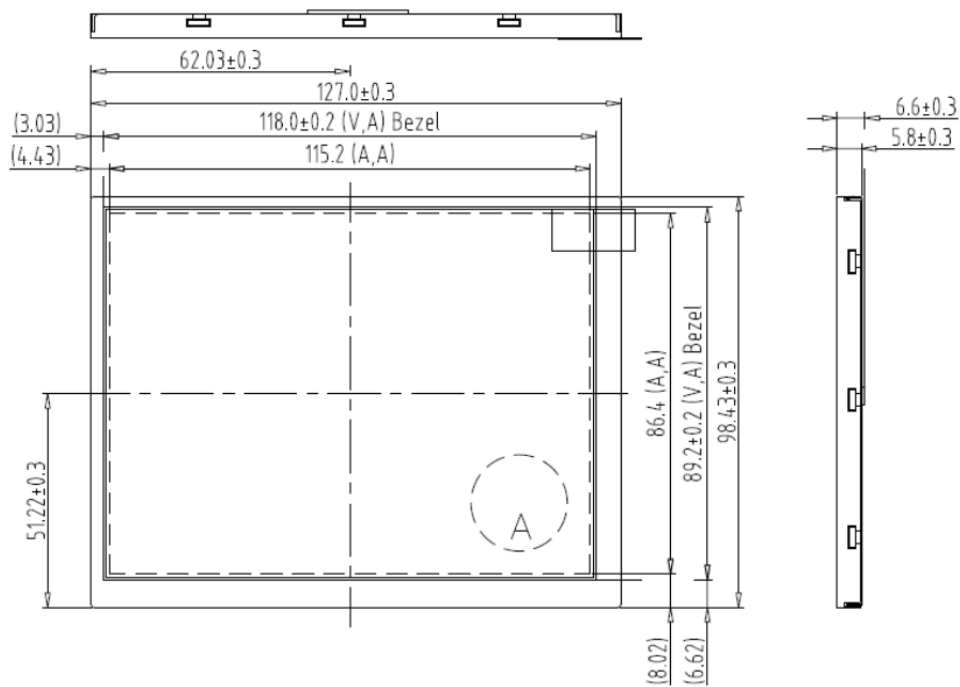

3. Absolute Maximum Ratings

3.1 Electrical Absolute max. ratings

Item	Symbol	Condition	Min.	Max.	Unit	Remark
Power voltage	VCC	GND=0	-0.3	3.96	V	
Logic Input Voltage Range	VIN	GND=0	-0.3	VCC +0.3	V	Note(1)

Note(1) HD, VD, DENA, DCLK, R0~R7, G0~G7, B0~B7.

Note(2) The following are maximum values which, if exceeded, may cause operation or damage to the unit.

3.2 Environmental Absolute Maximum Ratings

Item	Operating		Storage		Remark
	Min.	Max.	Min.	Max.	
Temperature	-20	70	-30	80	Note(2),(3), (4),(5),(6),(7)
Humidity	Note(1)		Note(1)		
Corrosive Gas	Not Acceptable		Not Acceptable		

Note(1) Ambient temperature Temp. $\leq 60^{\circ}\text{C}$: 90% RH max

Note(2) For storage condition Ta at $-30^{\circ}\text{C} < 240\text{h}$, at $80^{\circ}\text{C} < 240\text{h}$

Note(3) For operating condition Ta at $-20^{\circ}\text{C} < 100\text{h}$, at $70^{\circ}\text{C} < 240\text{h}$

Note(4) Background color changes slightly depending on ambient temperature. This phenomenon is reversible.

Note(5) The response time will be slower at low temperature.

Note(6) Only operation is guaranteed at operating temperature. Contrast, response time, another display quality are evaluated at $+25^{\circ}\text{C}$

Note(7) When LCM panel is operated over 60°C (center of the panel surface temperature), the IAK of the LED back-light should be adjusted to 105 mA

Note(8) This is center of the panel surface temperature, not ambient temperature.

Note(9) At 25°C

4. Optical Characteristics

Item		Symbol	Condition	Min.	Typ.	Max.	Unit	Note
Viewing Angle	Hor.	θU	$CR \geq 10$	75	85	--	deg.	(1),(4)
		θD		75	85	--		
	Ver.	θL		75	85	--		
		θR		75	85	--		
Contrast ratio		CR	$\Theta = \Phi = 0^\circ$	800	1200	--	--	(1),(2)
Response Time		$T_R + T_F$	$\Theta = \Phi = 0^\circ$	--	30	45	msec	(1),(3)
NTSC		(%)		55	60	--	%	
Color chromaticity	Red	R_x	$\Theta = \Phi = 0^\circ$	Typ. -0.05	0.630	Typ. +0.05	--	(1),(4),(5)
		R_y			0.312			
	Green	G_x			0.278			
		G_y			0.583			
	Blue	B_x			0.147			
		B_y			0.115			
	White	W_x			0.312			
		W_y			0.356			
Luminance (IAK=TBDmA)		L	$\Theta = \Phi = 0^\circ$	400	500	--	cd/m ²	(1),(6)
Luminance Uniformity		ΔL	$\Theta = \Phi = 0^\circ$	70	-	-	%	(7)

Measuring Condition

Ta=25°C. To be measured on the center area of panel after 10 minutes operation. LED Back-light IAK=140 mA.

- Measuring surrounding : Dark room
- Ambient temperature : 25±2°C
- 15min. Warm-up time.

Note(1) Definition of Viewing Angle

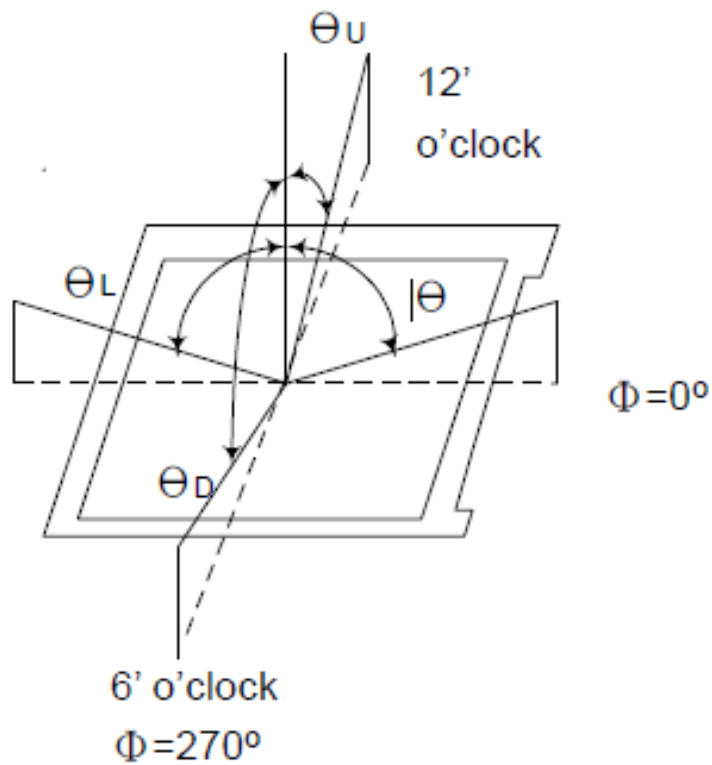

Note(2) Definition of Contrast Ratio (CR) :

Contrast ratio is calculated with the following formula.

$$\text{Contrast ratio (CR)} = \frac{\text{Photo detector output when LCD is at "White" state}}{\text{Photo detector Output when LCD is at "Black" state}}$$

Note(3) Definition of Response Time : Sum of TR and TF

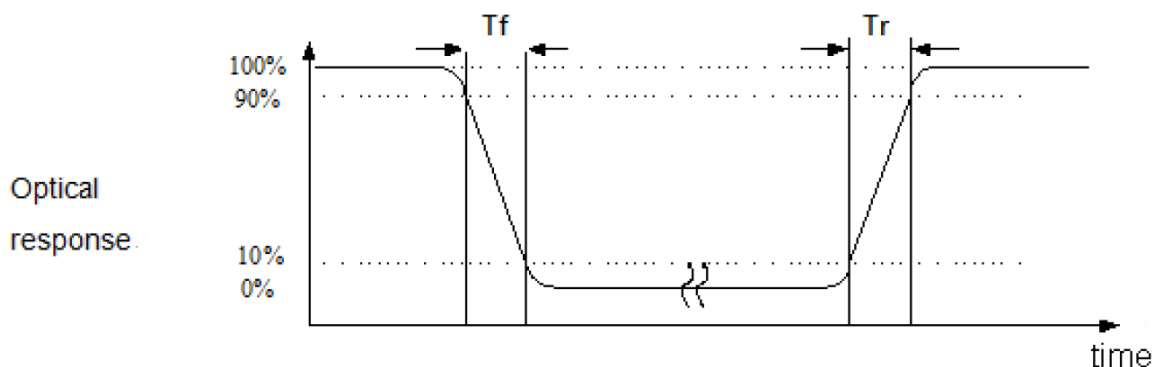

Note(4) Definition of optical measurement setup

The optical characteristics should be measured in dark room. After 30 minutes operation, the optical properties are measured at the center point of the LCD screen. (Response time is measured by Photo detector TOPCON BM-7, other items are measured by BM-5A/Field of view: 1° / Height: 500mm.)

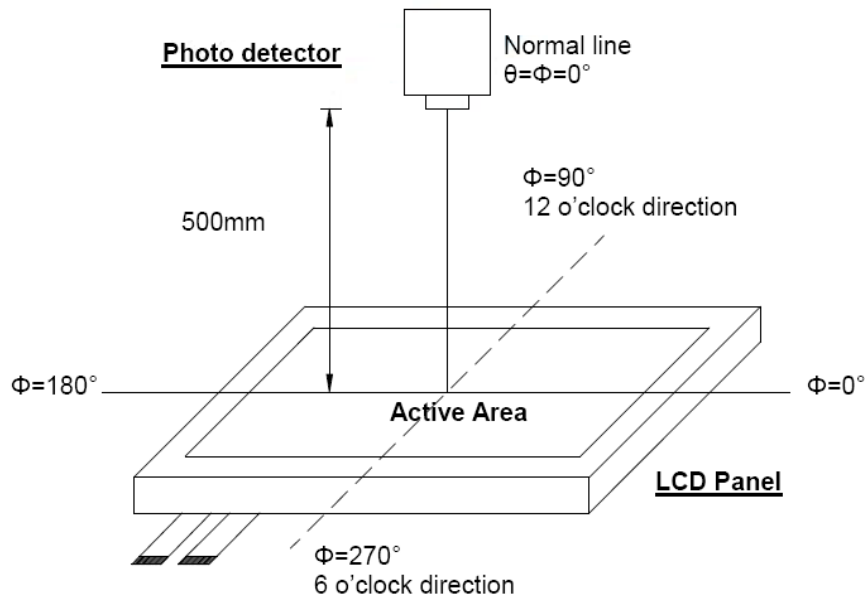

Note(5) Definition of color chromaticity (CIE1931)

Color coordinated measured at center point of LCD.

All input terminals LCD panel must be ground when measuring the center area of the panel.

Note(6) Luminance is measured at point 5 of the display.

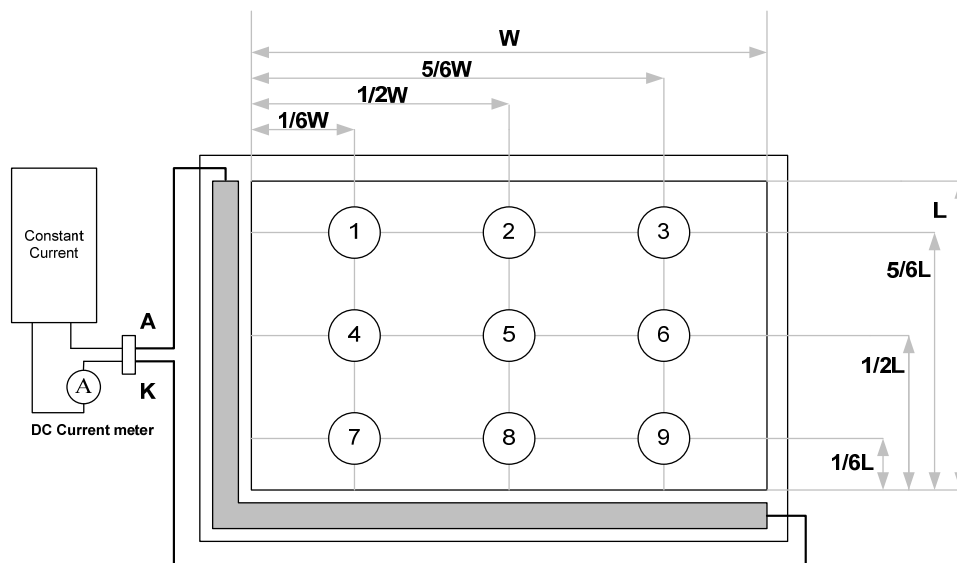

Note(7) Definition of Luminance Uniformity

Active area is divided into 9 measuring areas (Refer to bellow figure).
 Every measuring point is placed at the center of each measuring area.

$$\text{Luminance Uniformity (Yu)} = \frac{B_{\min}}{B_{\max}}$$

L ----- Active area length W ----- Active area width

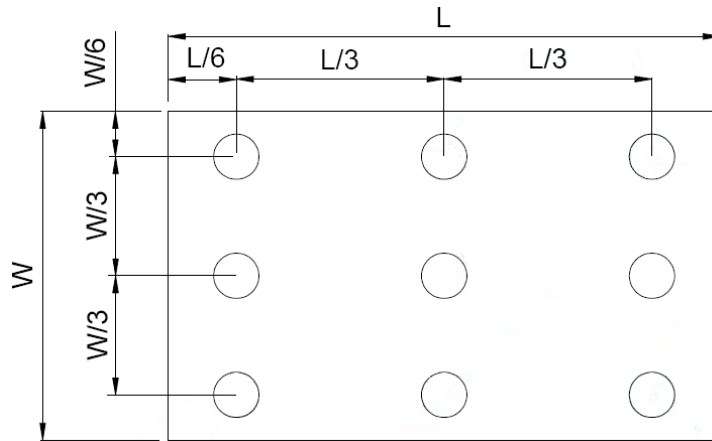

B_{max}: The measured maximum luminance of all measurement position.

B_{min}: The measured minimum luminance of all measurement position.

5. Electrical Characteristics

5.1 DC Characteristics

Item	Symbol	Min.	Typ.	Max.	Unit	Note
Power supply voltage	VCC	3.0	--	3.6	V	
Input voltage for logic	H Level	$0.7^* V_{CC}$	--	VCC	V	(1)
	L Level	GND	--	$0.3^* V_{CC}$	V	

Note(1) HD, VD, DENA, DCLK, and R0~R7, G0~G7, B0~B7, DISP.

Note(2) $f_V = 60\text{Hz}$, $T_a = 25^\circ\text{C}$, Display pattern : All White.

Note(3) *:Will be reference only

5.2 Electrical Characteristic Of LED Backlight

Item	Symbol	Min.	Typ.	Max.	Unit	Note
LED Forward Voltage	VAK	7.8	8.2	10.5	V	IAK=140mA, Ta=25°C
LED Forward Current	IAK	--	140	--	mA	Ta=25°C
Power Voltage For VLED	VLED	--	5.0	--	V	
Current For VLED	Iled	--	270	--	mA	VLED=5V
LED life time			50k	-	Hrs.	IAK=140mA, Ta=25°C

Note(1) Ta means ambient temperature of TFT-LCD module.

Note(2) If the module is driven by high current or at high ambient temperature & humidity condition. The operating life will be reduced.

Note(3) The constant current source is needed for LED back-light driving.

Note(4) Operating life means brightness goes down to 50% minimum brightness.
LED life time is estimated data. Ta=25°C

Note(5) The structure of LED B/L shows as below.

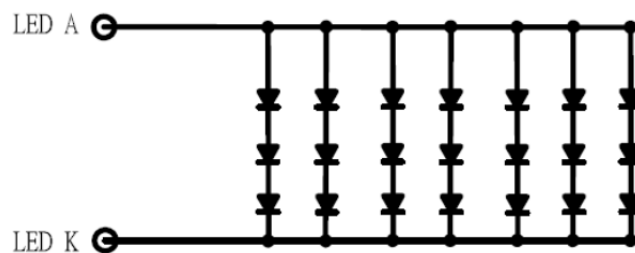

Note(6) When LCM is operated over 60°C ambient temperature, the IAK of the LED backlight should be adjusted to 105 mA max

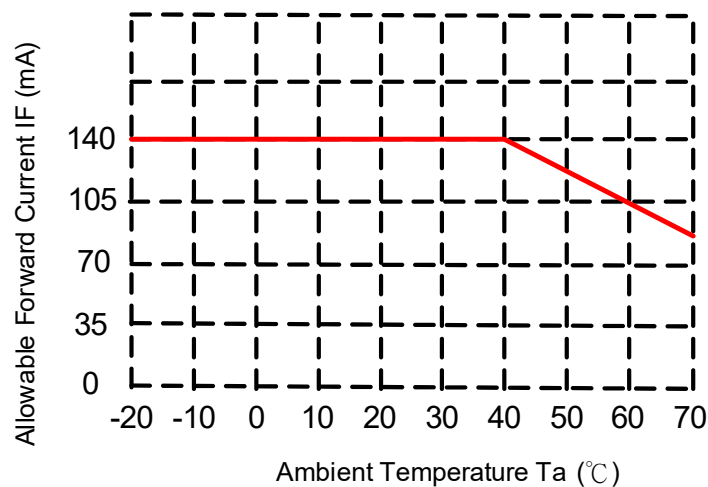

6. Interface Pin Assignment

Pin No	Symbol	Function
1	U/D	Up or Down Display Control
2	(NC)	No connection
3	Hsync(NC)	Horizontal SYNC. (Sync mode used)
4	VLED	Power Supply for LED :5V
5	VLED	Power Supply for LED :5V
6	VLED	Power Supply for LED :5V
7	Vcc	Power Supply for LCD
8	Vsync(NC)	Vertical SYNC. (Sync mode used)
9	DE	Data Enable
10	Vss	Power Ground
11	Vss	Power Ground
12	ADJ	Adjust for LED Brightness
13	B5	Blue Data 5 (MSB)
14	B4	Blue Data 4
15	B3	Blue Data 3
16	Vss	Power Ground
17	B2	Blue Data 2
18	B1	Blue Data 1
19	B0	Blue Data 0 (LSB)
20	Vss	Power Ground
21	G5	Green Data 5 (MSB)
22	G4	Green Data 4
23	G3	Green Data 3
24	Vss	Power Ground
25	G2	Green Data 2
26	G1	Green Data 1
27	G0	Green Data 0 (LSB)
28	Vss	Power Ground
29	R5	Red Data 5 (MSB)
30	R4	Red Data 4
31	R3	Red Data 3
32	Vss	Power Ground
33	R2	Red Data 2
34	R1	Red Data 1
35	R0	Red Data 0 (LSB)
36	Vss	Power Ground
37	Vss	Power Ground
38	DCLK	Clock Signals
39	Vss	Power Ground
40	L/R	Left or Right Display Control

NOTE :

1. ADJ adjust brightness to control Pin , Pulse duty the bigger the brighter.

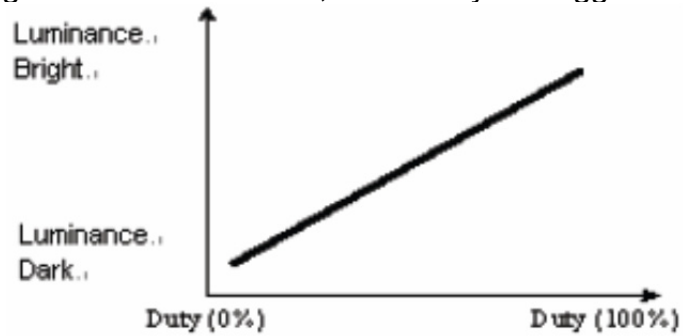

2. ADJ signal = 0 ~ 5.0V , operation frequency : 200Hz~20KHz

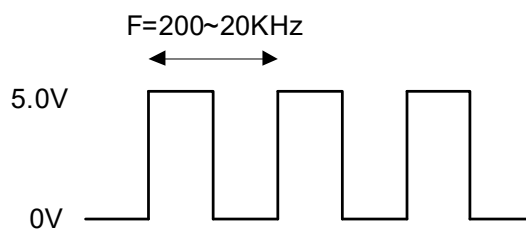

3. VSS Pin must ground contact , can not be floating.

4. U/D and L/R are controlled function

L/R	U/D	Function
1	0	Normally display
0	0	Left and Right opposite
1	1	Up and Down opposite
0	1	Left and Right opposite , Up and Down opposite

7. Interface Timing

AC electrical characteristics

Parameter Symbol		SPEC			Unit
		Min	Typ	Max	
HSD setup time	T _{hst}	8	-	-	ns
HSD hold time	T _{hhd}	8	-	-	ns
VSD setup time	T _{vst}	8	-	-	ns
VSD hold time	T _{vhd}	8	-	-	ns
Data setup time	T _{dsu}	8	-	-	ns
Data hold time	T _{dhd}	8	-	-	ns
DE setup time	T _{esu}	8	-	-	ns
DE hold time	T _{ehd}	8	-	-	ns
VDD Power On Slew rate	T _{POR}	-	-	20	ms
RSTB pulse width	T _{Rst}	10	-	-	us
CLKIN cycle time	T _{cph}	20	-	-	ns
CLKIN pulse duty	T _{cwh}	40	50	60	%
Output stable time	T _{sst}	-	-	6	us

Timing for RGB Interface

VDD=3.3V, VSS=0V, Ta=25°C

Parameter	Symbol	Min	Typ	Max	Unit	Remark
DCLK frequency	fclk	--	24	50	MHz	
Horizontal display area	thd	640			DCLK	
One Horizontal Line	th	--	760	--	DCLK	
HSD pulse width	thpw	1	48	255	DCLK	
HSD Back Porch(blanking)	thb	88			DCLK	
HSD Front Porch	thfp	1	32	255	DCLK	
DE Mode Blanking	th-thd	85	120	512	DCLK	
Vertical display area	tvd	480			TH	
VSD period time	tv	513	525	767	TH	
VSD pulse width	tvpw	3	3	255		
VSD Back Porch(blanking)	tvb	32			TH	
VSD Front Porch	tvfp	1	13	255	TH	
DE Mode Blanking	tv-tvd	4	45	255	TH	

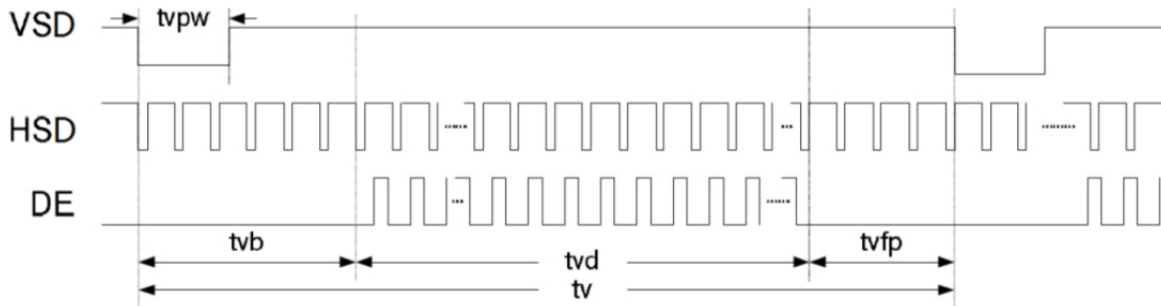
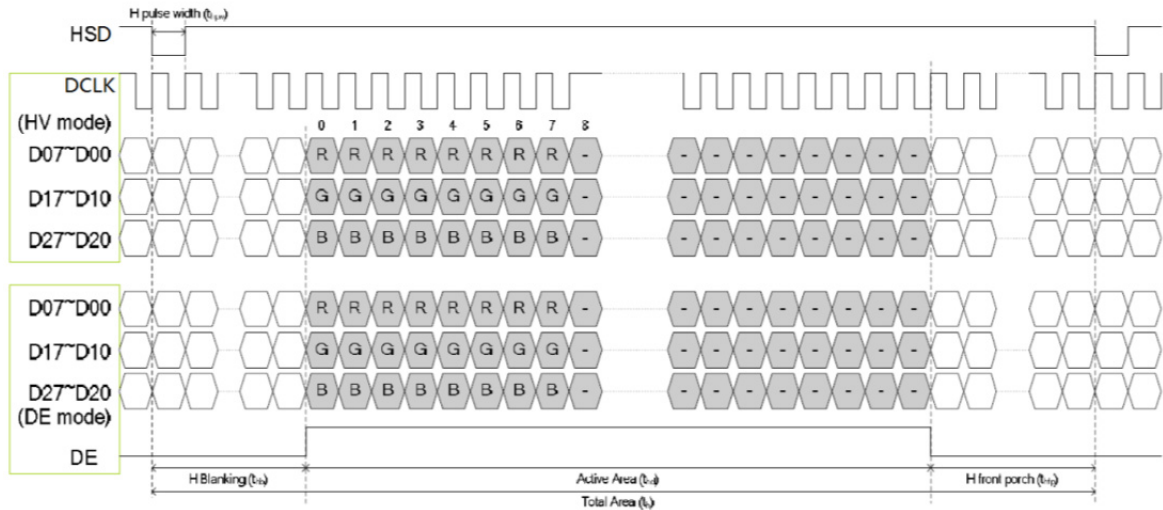

Input Clock and Data timing Diagram

Parameter	Symbol	Min.	Typ.	Max.	Unit	Conditions
CLKIN Frequency	Fclk	-	40	50	MHz	VDD=3.0V~3.6V
CLKIN Cycle Time	Tclk	20	25	-	ns	-
CLKIN Pulse Duty	Tcwh	40	50	60	%	Tclk
Time from HSD to Source Output	Thso		64		CLKIN	-
Time from HSD to LD	Thld		64		CLKIN	-
Time from HSD to STV	Thstv		2		CLKIN	-
Time from HSD to CKV	Thckv		20		CLKIN	-
Time from HSD to OEV	Thoev		4		CLKIN	-
LD Pulse Width	Twld		10		CLKIN	-
CKV Pulse Width	Twckv		66		CLKIN	-
OEV Pulse Width	Twoev		74		CLKIN	-

8. Power On/Off Sequence

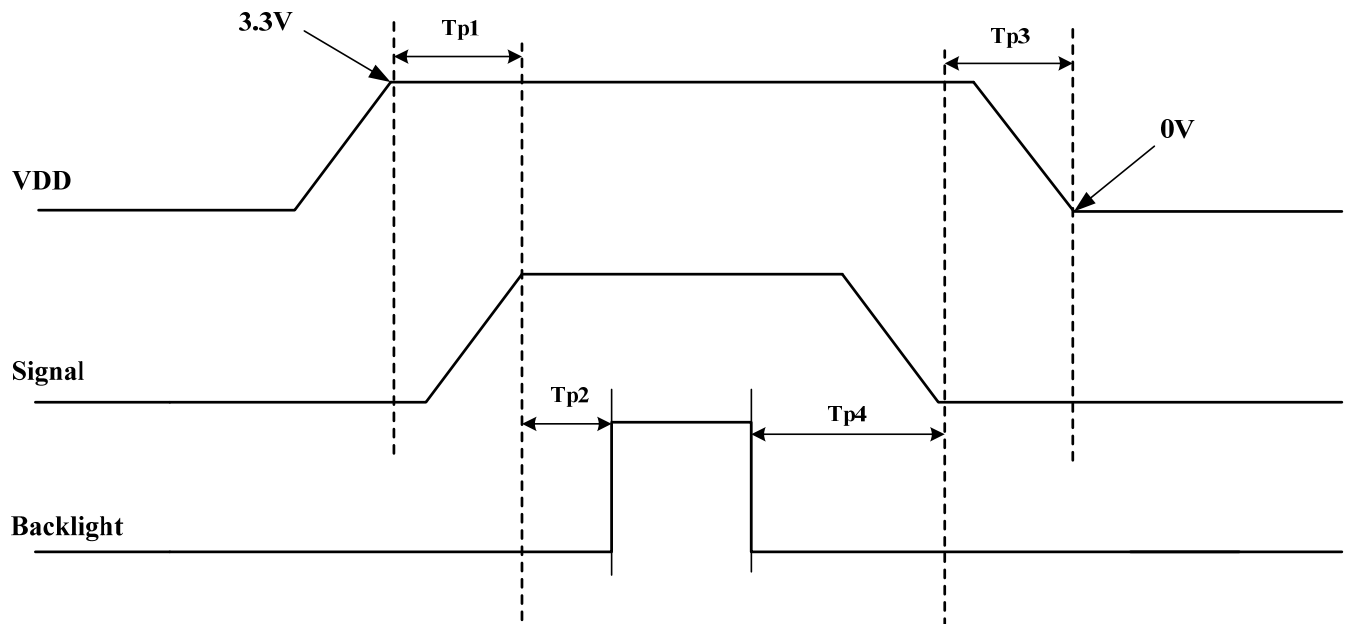

Item	Symbol	Value			Units	Remark
		Min.	Typ.	Max.		
VDD on to signal starting	Tp1	5	-	50	ms	
Signal starting to backlight on	Tp2	150	-	-	ms	
Signal off to VDD off	Tp3	5	-	50	ms	
Backlight off to signal off	Tp4	150	-	-	ms	

9. Displayed Color and Input Data Data Signal

COLOR		INPUT DATA																							
		R DATA						G DATA						B DATA											
		R7	R6	R5	R4	R3	R2	R1	R0	G7	G6	G5	G4	G3	G2	G1	G0	B7	B6	B5	B4	B3	B2	B1	B0
		MSB			LSB			MSB			LSB			MSB			LSB								
BASIC COLOR	BLACK	0	0	0	0	0	0	0	0	0	0	0	0	0	0	0	0	0	0	0	0	0	0	0	
	RED(255)	1	1	1	1	1	1	1	1	0	0	0	0	0	0	0	0	0	0	0	0	0	0	0	
	GREEN(255)	0	0	0	0	0	0	0	0	1	1	1	1	1	1	1	0	0	0	0	0	0	0	0	
	BLUE(255)	0	0	0	0	0	0	0	0	0	0	0	0	0	0	0	1	1	1	1	1	1	1	1	
	CYAN	0	0	0	0	0	0	0	0	1	1	1	1	1	1	1	1	1	1	1	1	1	1	1	
	MAGENTA	1	1	1	1	1	1	1	1	0	0	0	0	0	0	0	1	1	1	1	1	1	1	1	
	YELLOW	1	1	1	1	1	1	1	1	1	1	1	1	1	1	1	0	0	0	0	0	0	0	0	
	WHITE	1	1	1	1	1	1	1	1	1	1	1	1	1	1	1	1	1	1	1	1	1	1	1	
RED	RED(1)	0	0	0	0	0	0	0	1	0	0	0	0	0	0	0	0	0	0	0	0	0	0	0	
	RED(2)	0	0	0	0	0	0	1	0	0	0	0	0	0	0	0	0	0	0	0	0	0	0	0	
	RED(255)	1	1	1	1	1	1	1	1	0	0	0	0	0	0	0	0	0	0	0	0	0	0	0	
GREEN	GREEN(1)	0	0	0	0	0	0	0	0	0	0	0	0	0	0	1	0	0	0	0	0	0	0	0	
	GREEN(2)	0	0	0	0	0	0	0	0	0	0	0	0	0	1	0	0	0	0	0	0	0	0	0	
	GREEN(255)	0	0	0	0	0	0	0	0	1	1	1	1	1	1	1	0	0	0	0	0	0	0	0	
BLUE	BLUE(1)	0	0	0	0	0	0	0	0	0	0	0	0	0	0	0	0	0	0	0	0	0	0	1	
	BLUE(2)	0	0	0	0	0	0	0	0	0	0	0	0	0	0	0	0	0	0	0	0	0	1	0	
	BLUE(255)	0	0	0	0	0	0	0	0	0	0	0	0	0	0	0	1	1	1	1	1	1	1	1	

10. Reliability Test Conditions

Test Item	Test Conditions	Note
High Temperature Operation	70±3°C , t=240 hrs	
Low Temperature Operation	-20±3°C , t=240 hrs	
High Temperature Storage	80±3°C , t=240 hrs	(1),(2)
Low Temperature Storage	-30±3°C , t=240 hrs	(1),(2)
Storage Humidity Test	60 °C, Humidity 90%, 240 hrs	(1),(2)
Vibration Test (Packing)	Sweep frequency : 10 ~ 50 ~ 10 Hz/1min Amplitude : 0.75mm Test direction : X.Y.Z/3 axis Duration : 30min/each axis	(2)

Note(1) Condensation of water is not permitted on the module.

Note(2) The module should be inspired after 1 hour storage in normal conditions (15~35°C , 45~65%RH).

Note(3) The module shouldn't be tested over one condition, and all the tests are independent.

Note(4) All reliability tests should be done without the protective film.

Definitions of life end point:

- Current drain should be smaller than the specific value.
- Function of the module should be maintained.
- Appearance and display quality should not have degraded noticeably.
- Contrast ratio should be greater than 50% of initial value.

11. Use Precautions

11.1 Handling precautions

- (1) The polarizing plate may break easily so be careful when handling it. Do not touch, press or rub it with a hard-material tool like tweezers.
- (2) Do not touch the polarizing plate surface with bare hands so as not to make it dirty. If the surface or other related part of the polarizing plate is dirty, soak a soft cotton cloth or chamois leather in benzine and wipe off with it. Do not use chemical liquids such as acetone, toluene and isopropyl alcohol. Failure to do so may bring chemical reaction phenomena and deteriorations.
- (3) Remove any spit or water immediately. If it is left for hours, the suffered part may deform or decolorize.
- (4) If the LCD element breaks and any LC stuff leaks, do not suck or lick it. Also if LC stuff is stuck on your skin or clothing, wash thoroughly with soap and water immediately.

11.2 Installing precautions

- (1) The PCB has many ICs that may be damaged easily by static electricity. To prevent breaking by static electricity from the human body and clothing, earth the human body properly using the high resistance and discharge static electricity during the operation. In this case, however, the resistance value should be approx. $1M\Omega$ and the resistance should be placed near the human body rather than the ground surface. When the indoor space is dry, static electricity may occur easily so be careful. We recommend the indoor space should be kept with humidity of 60% or more. When a soldering iron or other similar tool is used for assembly, be sure to earth it.
- (2) When installing the module and ICs, do not bend or twist them. Failure to do so may crack LC element and cause circuit failure.
- (3) To protect LC element, especially polarizing plate, use a transparent protective plate (e.g., acrylic plate, glass etc) for the product case.
- (4) Do not use an adhesive like a both-side adhesive tape to make LCD surface (polarizing plate) and product case stick together. Failure to do so may cause the polarizing plate to peel off.

11.3 Storage precautions

- (1) Avoid a high temperature and humidity area. Keep the temperature between 0°C and 35°C and also the humidity under 60%.
- (2) Choose the dark spaces where the product is not exposed to direct sunlight or fluorescent light.
- (3) Store the products as they are put in the boxes provided from us or in the same conditions as we recommend.

11.4 Operating precautions

- (1) Do not boost the applied drive voltage abnormally. Failure to do so may break ICs. When applying power voltage, check the electrical features beforehand and be careful. Always turn off the power to the LC module controller before removing or inserting the LC module input connector. If the input connector is removed or inserted while the power is turned on, the LC module internal circuit may break.
- (2) The display response may be late if the operating temperature is under the normal standard, and the display may be out of order if it is above the normal standard. But this is not a failure; this will be restored if it is within the normal standard.
- (3) The LCD contrast varies depending on the visual angle, ambient temperature, power voltage etc. Obtain the optimum contrast by adjusting the LC drive voltage.
- (4) When carrying out the test, do not take the module out of the low-temperature space suddenly. Failure to do so will cause the module condensing, leading to malfunctions.
- (5) Make certain that each signal noise level is within the standard (L level: 0.2V_{dd} or less and H level: 0.8V_{dd} or more) even if the module has functioned properly. If it is beyond the standard, the module may often malfunction. In addition, always connect the module when making noise level measurements.
- (6) The CMOS ICs are incorporated in the module and the pull-up and pull-down function is not adopted for the input so avoid putting the input signal open while the power is ON.
- (7) The characteristic of the semiconductor element changes when it is exposed to light emissions, therefore ICs on the LCD may malfunction if they receive light emissions. To prevent these malfunctions, design and assemble ICs so that they are shielded from light emissions.
- (8) Crosstalk occurs because of characteristics of the LCD. In general, crosstalk occurs when the regularized display is maintained. Also, crosstalk is affected by the LC drive voltage. Design the contents of the display, considering crosstalk.

11.5 Other

- (1) Do not disassemble or take the LC module into pieces. The LC modules once disassembled or taken into pieces are not the guarantee articles.
- (2) Do not keep the LCD at the same display pattern continually. The residual image will happen and it will damage the LCD. Please use screen saver.
- (3) AMIPRE will provide one year warrantee for all products and three months warrantee for all repairing products.

12. Outline Dimension

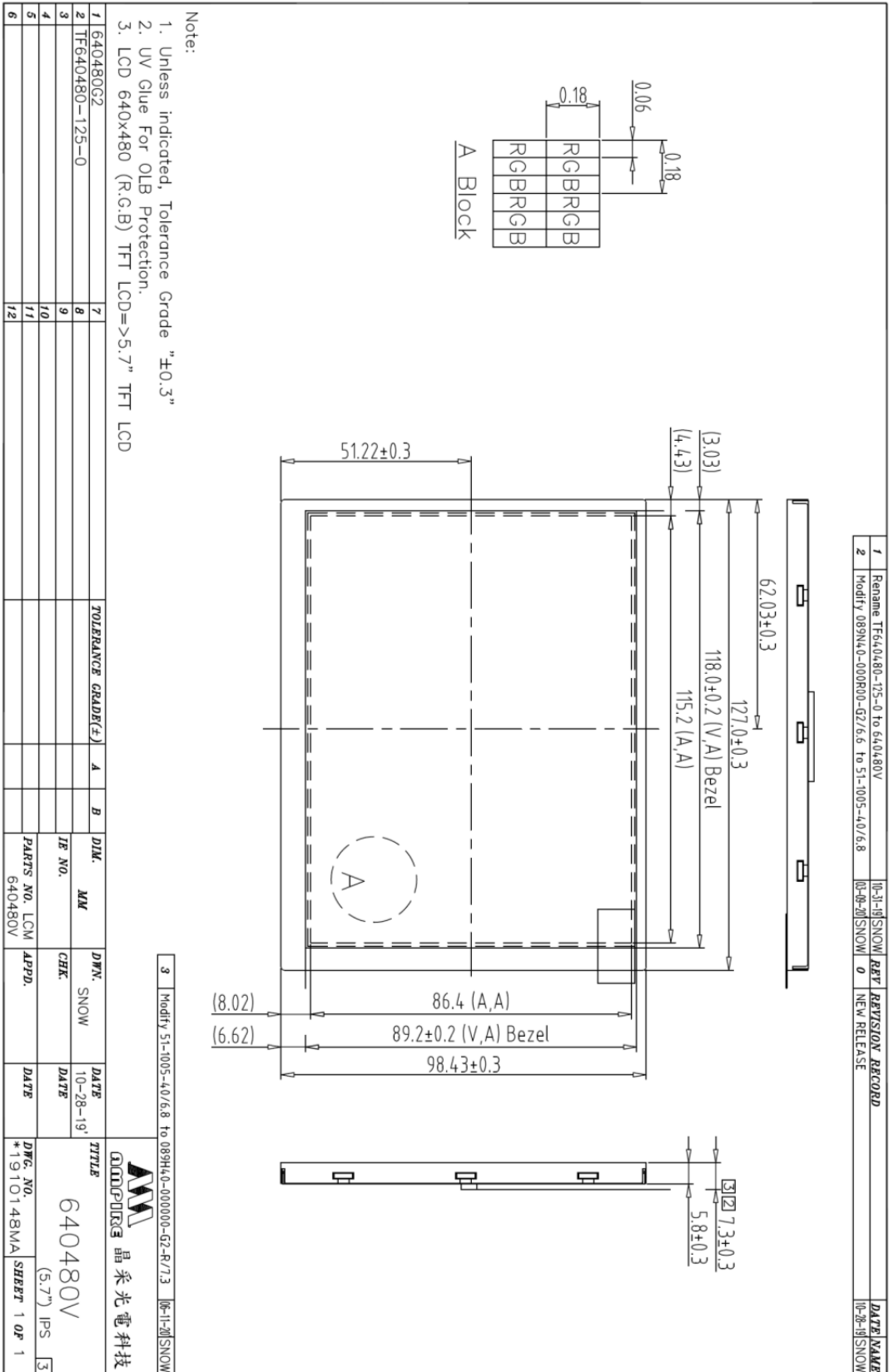

REV	REVISION RECORD	DATE	NAME
0	NEW RELEASE	10-28-19	SNOW
1	Rename: TF640480-125-0 to 640480V	10-31-19	SNOW
2	Modify: 089H4.0-000R0-62/7/6.6 to 51-1005-4/0/6.8	10-29-20	SNOW
3	Modify: 51-1005-4/0/6.8 to 089H4.0-000000-62-R/7.3	10-11-20	SNOW

CN1	
1 U/D	21 G5
2 DMS(NC)	22 G4
3 HSYNC(NC)	23 G3
4 VLED	24 VSS
5 VLED	25 G2
6 VLED	26 G1
7 VCC	27 G0
8 VSYNC(NC)	28 VSS
9 DE	29 R5
10 VSS	30 R4
11 VSS	31 R3
12 ADJ	32 VSS
13 B5	33 R2
14 B4	34 R1
15 B3	35 R0
16 VSS	36 VSS
17 B2	37 VSS
18 B1	38 DCLK
19 B0	39 VSS
20 VSS	40 L/R

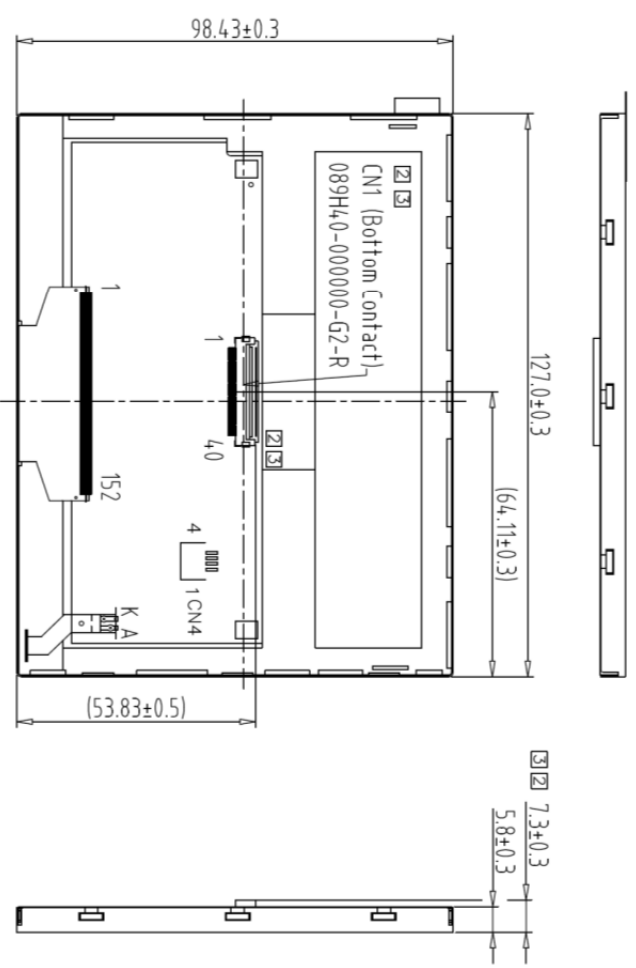

Back view

AMPIRE 晶采光電科技

NO.	REV	DESCRIPTION	TOLERANCE GRADE(±)	A	B	DIM.	UNIT	DWN.	CHECK	DATE	DATE	TITLE	DWG. NO.	SHEET	OF
1	640480G2														
2	TF640480-125-0														
3															
4															
5															
6															

- Note:
1. Unless indicated, Tolerance Grade "B" is adopted.
 2. UV Glue For OLB Protection.
 3. Main LCD 640x480 (R.G.B) TFT LCD => 5.7" TFT LCD